

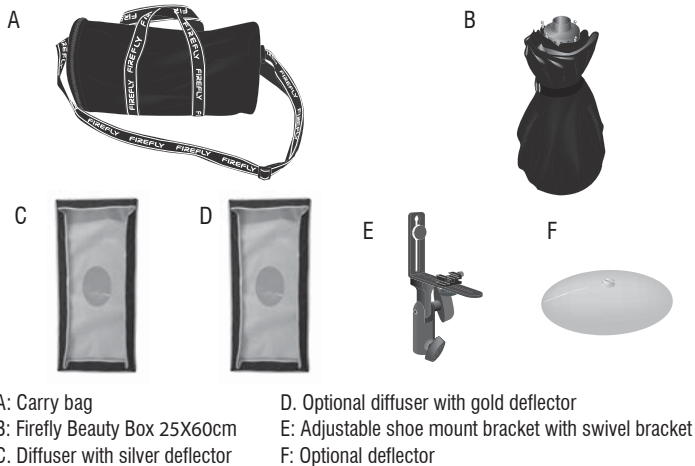

1. Parts



2. Setting up procedure

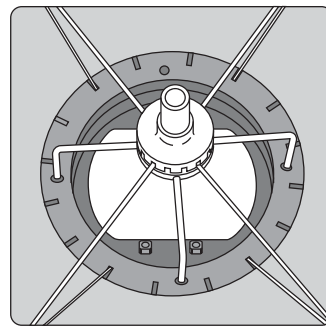
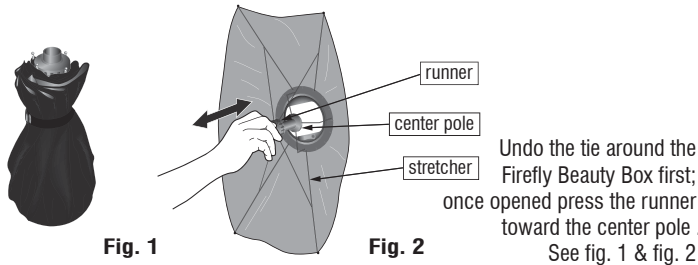

Fig. 3

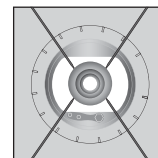

Fig. 4 O

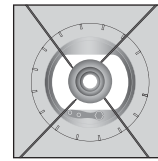

Fig. 5 X

The grooves inside of the runners should connect with two projecting parts in the center pole. When the runners and center pole grooves are connected, all the stretchers should be straight and be equal. See fig. 3, fig. 4 and fig. 5

If they do not connect perfectly, rotate the runner slightly until you get the correct connection. (If this does not happen, the stretchers will twist and this may cause stress on the hinges and cause damage).

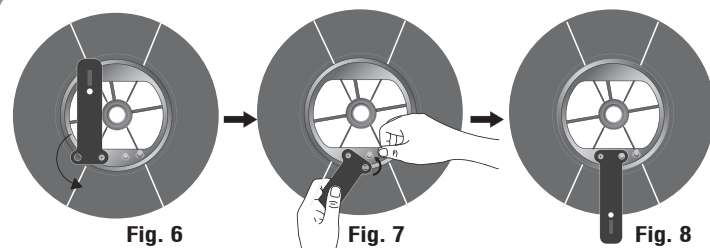

Fig. 6

Fig. 7

Fig. 8

Rotate the attached arm on the swivel bracket anticlockwise while pressing the button attached to the ring. Locate the hole in the arm over the stud then release the button so that the stud protrudes through the hole in the arm which will lock it securely into place. See fig. 6, fig. 7 and fig. 8

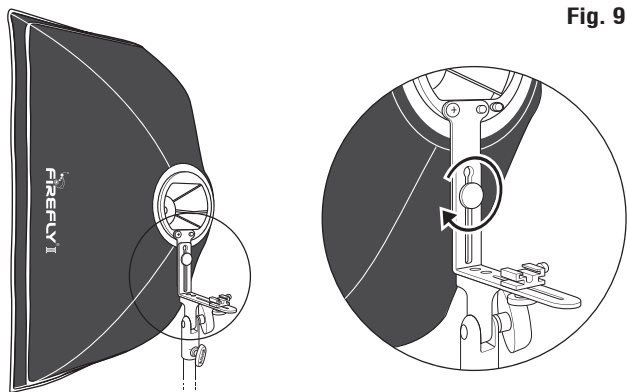

Fig. 9

Screw the shoe mounting bracket to the swivel bracket as indicated. See fig. 9

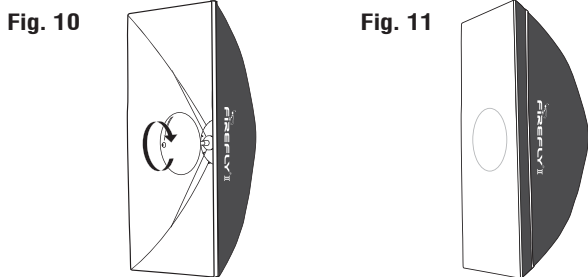

Fig. 10

Fig. 11

Screw a completely assembled deflector onto the center pole which is screw thread. Use without covering a front diffuser to enjoy beauty dish lighting. See fig. 10
Cover the front of Firefly Beauty Box with the included diffuser for softer light See fig. 11

A diffuser with a gold deflector is available as an option from your Aurora dealer.

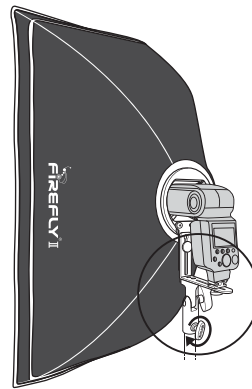

Fig. 12

After attaching the speedlight onto the shoe, mount the assembled Firefly Beauty Box to a light stand or camera bracket to use. See fig. 12

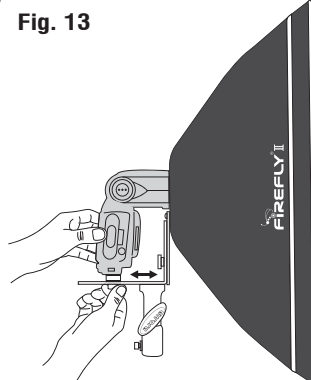

Fig. 13

To position the flash head correctly into the softbox rear aperture, move the flash forward or backward and then secure with the locking screw. See fig 13. The adaptor ring rotates 360 degree and so does the Firefly Beauty Box

To keep pace with our continued design and development this product may be modified by Aurora Lite Bank at any time.